



BEYOND | **Logistic**





pull



pull



side

4 legs

swivel

bench

pull showing

features



trolley
available



Una seduta dal **disegno moderno e accattivante**, con monoscocca in plastica disponibile in vari colori.

È ideale per i diversi **ambienti Community**, in cui siano richieste **impilabilità, leggerezza e semplicità di utilizzo**: dal **Contract**, alle **aree d'attesa**, fino al **settore formation**.

Oltre alle versioni 4 gambe e a slitta, prevede le versioni girevole e panca.

*Chair with a **modern and attractive design**, featuring a monocoque plastic seat available in a range of colours.*

*Ideal for different **Community environments**, where **stackability, lightness and ease of use** are required: from **Contract**, to **waiting areas**, to the **training sector**.*

In addition to the 4-legged and sled versions, it is also available in swivel and bench versions.

pull

slide

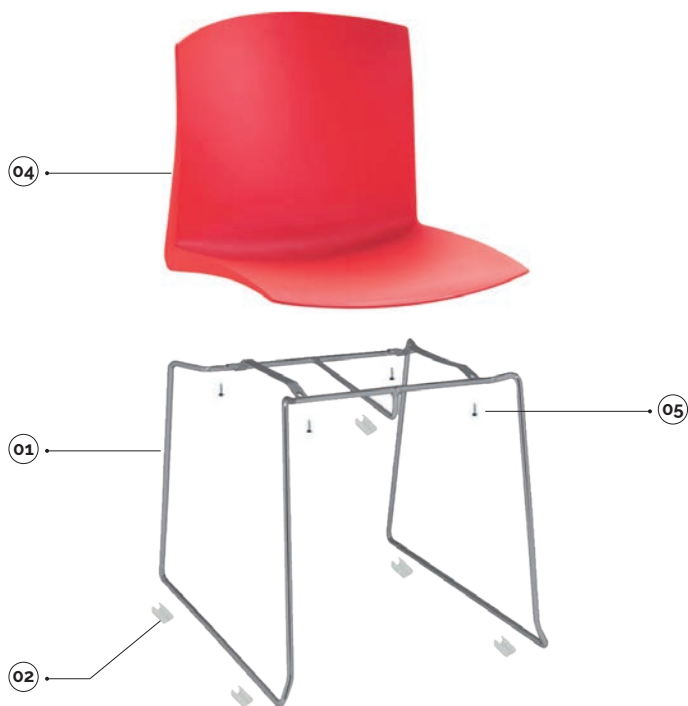

plastic colours

- grigio/grey ral 7035
- nero/black
- arancio/orange ral 2003
- bianco/white 218
- rosso/red 527

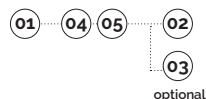

main component sizes

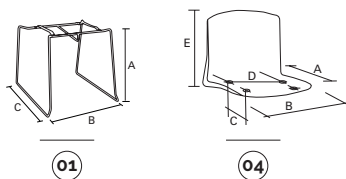

optional

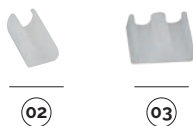

01 speedy-sgabello in tondino per scocca modello pull speedy-round bar for the shell mod.pull

code	finishing	q.kit	q.pack	a	b	c	kg.x1	vol.x1
113410-025	● cromato/chrome	x1	120	450	580	570	3,05	mc. 0,04

02 confezione di basi a pinza antirotazione per tondino colore neutro neutral clips base for wire d.11 package

code	finishing	q.kit	q.pack
137006-070	○ neutro/neutral	x4	200

03 base piana a pinza doppia in pe per tondo per unione sedie double flat clip base for tube

code	finishing	q.kit
134006-021	○ neutro/neutral	x4

04 pull-scocca intera modello pull pull-shell mod. pull

code	finishing	q.kit	q.pack	a	b	c	d	e	kg.x1	vol.x1
133902-026	● rosso/red 527	x1	10	520	450	255	315	393	1,60	mc. 0,021

05 vite tc+combi 6x16 testa cilindrica a croce zincata (vite fissaggio scocca) screw combi 6x16 cylindrical head cross zinc (screw for fix shell)

code	finishing	q.kit
117811-181	○ zincata/zinc	x4

speedy-carrello portasedie con accessori nero speedy-trolley for chairs with accessories black

code	finishing
110803-358	● nero/black



for all colour codes, see page 101

pull

4-legs



plastic colours

- grigio/grey ral 7035
- nero/black
- arancio/orange ral 2003
- bianco/white 218
- rosso/red 527

main component sizes

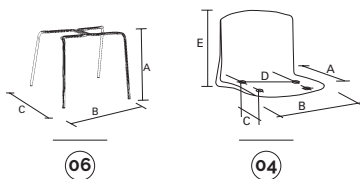

optional

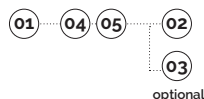

06 pull-sgabello in tubo d.18 per scocca pull-stool tube d.18 for shell

code	finishing	q.kit	q.pack	a	b	c	kg.x1	vol.x1
110603-075	● nero/black	x1	200	450	470	490	2,00	mc. 0,02
110604-095	● grigio/grey	x1	200	450	470	490	2,00	mc. 0,02
110610-045	● cromato/chrome	x1	200	450	470	490	2,00	mc. 0,02

07 confezione puntali tondi d.18 neri black inner round caps d.18 package

code	finishing	q.kit	q.pack
137003-072	● nero/black	x4	200

08 confezione viti hilo 5,5x30 testa svasata a croce zincata (vite per fissaggio scocca) cross screws hilo d.5x30 flared zinc (screw for shell fixing) package

code	finishing	q.kit	q.pack
117011-071	○ zincata/zinc	x4	200

04 pull-scocca intera modello pull pull-shell mod. pull

code	finishing	q.kit	q.pack	a	b	c	d	e	kg.x1	vol.x1
133903-025	● nero/black	x1	10	520	450	255	315	393	1,60	mc. 0,021

09 supporto per impilabilita' scocca neutro support for shell stackability neutral

code	finishing	q.kit	kg.x1
134006-030	○ neutro/neutral	x1	0,025

10 vite hilo tb 5x14 nera hilo cross screw tb 5x14 black

code	finishing	q.kit
117803-155	● nero/black	x1

pull-carrello portasedie con accessori nero pull-trolley for chairs with accessories black

code	finishing
110803-347	● nero/black



for all colour codes, see page 101

pull swivel



plastic colours

- grigio/grey ral 7035
- nero/black
- arancio/orange ral 2003
- bianco/white 218
- rosso/red 527

main component sizes

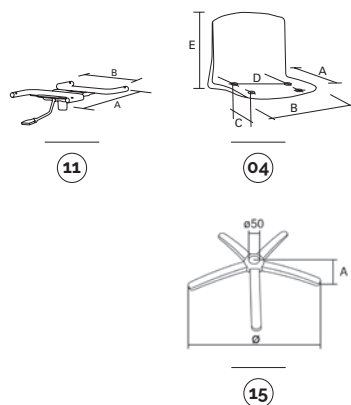

options

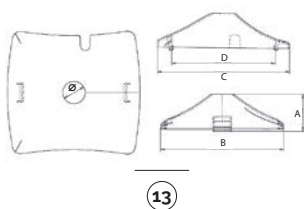

11 04 08 12 13 15
optional

11 supporto girevole a gas per scocca pull swivel metal frame for gas lift for pull shell

code	finishing	q.kit	q.pack	a	b	kg.x1	vol.x1
110903-025	● nero/black	x1	10	315	255	1.40	mc. 0.004

12 confezione tappi copristesta d.18 neri black cover head caps d.18 package

code	finishing	q.kit	q.pack
137003-070	● nero/black	x4	200

04 pull-scocca intera modello pull pull-shell mod. pull

code	finishing	q.kit	q.pack	a	b	c	d	e	kg.x1	vol.x1
133907-025	● arancio/orange ral 2003	x1	10	520	450	255	315	393	1.60	mc. 0.021

08 confezione viti hilo 5,5x30 testa svasata a croce zincata (vite per fissaggio scocca) cross screws hilo d.5x30 flared zinc (screw for shell fixing) package

code	finishing	q.kit	q.pack
117011-071	○ zincata/zinc	x4	200

13 cpg-copertina in plastica per telaio girevole cpg-plastic cover for swivel frame

code	finishing	q.kit	q.pack	a	b	c	d	ø	kg.x1	vol.x1
130903-000	● nero/black	x1	50	60	200	210	167	36	0.1	mc. 0.0015

15 b40 base in metallo d.640 con coprisaldatura b40 metal base d.640 with cover welding

code	finishing	q.kit	q.pack	a	ø	kg.x1	vol.x1
110210-027	● cromato/chrome	x1	5	60	640	2.85	mc. 0.014

CPG
plastic cover for swivel frame



for all colour codes, see page 101

pull

bench



plastic colours

- grigio/grey ral 7035
- nero/black
- arancio/orange ral 2003
- bianco/white 218
- rosso/red 527

14 04 08 12

main component sizes

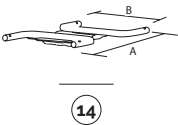

14 supporto per attacco scocca pull su panca
bench frame for pull shell

code	finishing	q.kit	q.pack	a	b	kg.x1	vol.x1
110703-085	● nero/black	x1	10	315	255	1.40	mc. 0.004

for the components below, see page 100

12 04 08



for all colour codes, see below

for the bench components, see page 201

optional

OPTIONAL
bench
connector

E-USB **NEW**
bench plug



JIM **NEW**
bench leg

APOLL
bench arm



plastic

90GM
bench leg

90GF
bench leg

100GM
bench leg

200GM
bench leg

PIONEER
bench arm



metal

CUT
bench leg

SLIM
bench leg

CUT
bench arm

SLIM
bench arm



aluminium

pull

optional colour codes



shell colour codes

04 scocche in plastica
plastic shells

- 133904-026 grigio/grey ral 7035
- 133903-025 nero/black
- 133907-025 arancio/orange ral 2003
- 133905-026 bianco/white 218
- 133902-026 rosso/red 527

