



BEYOND | **Solutions**





young / key / fabric



young / key / fabric



side

4 legs

4 legs with castors

swivel

bench

young/key/fabric showing



tools



configurator



brochure



video



Young, Key e Fabric, le nuove scocche in legno multistrato di faggio.

Tre scocche dal design distintivo, con foro centrale, a T o da tappezzare, tutte compatibili con i telai della famiglia Magix, in grado di consentire il massimo delle combinazioni.

Plus:

- scocca in legno multistrato di faggio;
- 5 colorazioni disponibili della scocca a vista;
- linea ergonomica;
- massima versatilità;
- la versione da tappezzare permette l'unicità di finitura.

Young, Key e Fabric sono ideali per l'ambiente Office.

Young, Key and Fabric, the new seat shells in beech plywood.

Three seat shells with a distinctive design, with central hole, T-shaped or to be upholstered, all compatible with the frames in the Magix family, thus providing an extensive range of combinations.

Advantages:

- seat shell in beech plywood;
- seat shell available in 5 colours;
- ergonomic shape;
- maximum versatility;
- the version to be upholstered enables a unique look to be achieved.

Young, Key and Fabric are ideal for Office environments.

young slide

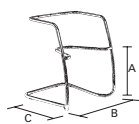
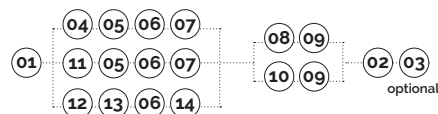

01

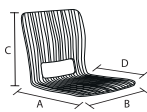

04

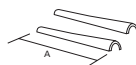

08



09



01 magix-base a slitta in tubo asform d.25 tappi esclusi
magix-slide frame pipe d.25 without caps

code	finishing	q.kit	q.pack	a	b	c	kg.x1	vol.x1
110503-009	● nero/black	x1	48	450	560	560	4,90	mc. 0,045
110504-112	● grigio/grey	x1	48	450	560	560	4,90	mc. 0,045
110510-095	● cromato/chrome	x1	48	450	560	560	4,90	mc. 0,045

02 magix-confezione accessori 50 picma + 290 p2pa
magix-pack of accessories 50 picma + 290 p2pa

code	finishing	q.kit	q.pack	kg.x1	vol.x1
137000-009	● nero/black	x1+x6	50+290	1,00	mc. 0,1413

03 piedino antibaltamento in plastica nero + viti
plastic black feet anti-upsetting + screws

code	finishing	q.kit	q.pack	kg.x1	vol.x1
134303-006	● nero/black	x2	100	0,025	mc. 0,0001

04 magix/young-monoscocca mult. ver. c/inserti
magix/young beech shell w/inserts

code	finishing	q.kit	q.pack	a	b	c	d	kg.x1	vol.x1
122107-015	● faggio/plywood	x1	5	556	487	396	396	3,11	mc. 0,0312
122115-015	● azzurro/blue	x1	5	556	487	396	396	3,11	mc. 0,0312
122116-015	● verde/green	x1	5	556	487	396	396	3,11	mc. 0,0312
122104-015	● tempesta/grey blue	x1	5	556	487	396	396	3,11	mc. 0,0312
122107-021	● arancione/orange	x1	5	556	487	396	396	3,11	mc. 0,0312

05 vite 4,8 tsp+ m6x30-zincata per il sedile
screw 4,8 tsp+ m6x30-zinc for the seat

code	finishing	q.kit
117711-192	○ zincata/zinc	x4

06 supporto schienale scocca legno
spacer for plywood shell

code	finishing	q.kit	q.pack	kg.x1	vol.x1
132103-077	● nero/black	x1	20	0,26	mc. 0,055
132105-077	○ avorio/ivory ral1013	x1	20	0,26	mc. 0,055

07 vite tspei m5x40 zincata bianca per lo schienale
screw tspei m5x40 white zinc for the back

code	finishing	q.kit
117711-154	○ zincata bianca/white zinc	x3

08 bracciolo destro e sinistro plastica conico
left right black plastic conic arm

code	finishing	q.kit	q.pack	a	kg.x1	vol.x1
131703-041	● nero/black	x2	200	205	0,04	mc. 0,0002
131703-042	○ avorio/ivory ral1013	x2	200	205	0,04	mc. 0,0002

09 confezioni viti trucciolari tsp+ d.4x25 zincate (per fissare braccioli)
shaving screws tsp+ d.4x25 zinc package (for arms)

code	finishing	q.kit	q.pack
117011-072	○ zincata/zinc	x4	200

main component sizes

optional

young

slide/armrest option

main component sizes

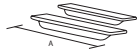

10



10 bracciolo destro e sinistro plastica nero left right black plastic arm

code	finishing	q.kit	q.pack	a	kg.x1	vol.x1
131703-040	● nero/black	x2	100	200	0,04	mc. 0.0004

slide/shell options

main component sizes

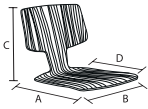

11



11 magix/key-monoscocca mult. ver. c/inserti magix/key beech shell w/inserts

code	finishing	q.kit	q.pack	a	b	c	d	kg.x1	vol.x1
122107-016	● faggio/plywood	x1	5	552	483	398	391	2,76	mc. 0.0312
122115-016	● azzurro/blue	x1	5	552	483	398	391	2,76	mc. 0.0312
122116-016	● verde/green	x1	5	552	483	398	391	2,76	mc. 0.0312
122104-016	● tempesta/grey blue	x1	5	552	483	398	391	2,76	mc. 0.0312
122107-022	● arancione/orange	x1	5	552	483	398	391	2,76	mc. 0.0312

and 05 07

spessore 11mm
thickness 11mm

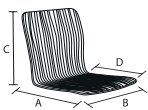

12



12 magix/fabric-monosc. mult. faggio x imbottiti c/inserti magix/fabric beech shell for upholstery w/inserts

code	finishing	q.kit	q.pack	a	b	c	d	kg.x1	vol.x1
122107-017	● faggio/plywood	x1	5	556	487	396	396	3,50	mc. 0.0312

13 vite 4.8 tsp+ m6x35 zincata bianca per il sedile screw 4.8 tsp+ m6x35-white zinc for the seat

code	finishing	q.kit
117711-183	● zincata bianca/white zinc	x4

14 vite tspei m5x45 zincata bianca per lo schienale screw tspei m5x45 white zinc for the back

code	finishing	q.kit
117711-156	● zincata bianca/white zinc	x3

spessore 11mm
thickness 11mm

key

4-legs

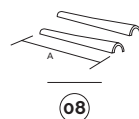
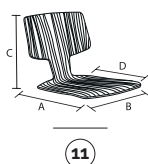
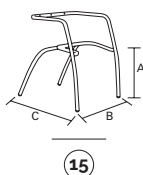
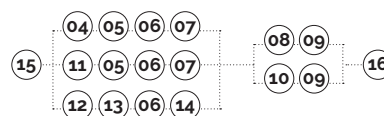

15 magix-telaio quattro gambe d.25 senza tappi magix-four legs frame d.25 without caps

code	finishing	q.kit	q.pack	a	b	c	kg.x1	vol.x1
110103-006	● nero/black	x1	30	450	550	550	4.10	mc. 0.045
110104-006	● grigio/grey	x1	30	450	550	550	4.10	mc. 0.045
110110-006	● cromato/chrome	x1	30	450	550	550	4.10	mc. 0.045

16 confezione puntali a testa sferica d.25 cap d.25 spherical head black package

code	finishing	q.kit	q.pack
137003-075	● nero/black	x4	120

11 magix/key-monoscocca mult. ver. c./inserti magix/key beech shell w/inserts

code	finishing	q.kit	q.pack	a	b	c	d	kg.x1	vol.x1
122107-016	● faggio/plywood	x1	5	552	483	398	391	2.76	mc. 0.0312
122115-016	● azzurro/blue	x1	5	552	483	398	391	2.76	mc. 0.0312
122116-016	● verde/green	x1	5	552	483	398	391	2.76	mc. 0.0312
122104-016	● tempesta/grey blue	x1	5	552	483	398	391	2.76	mc. 0.0312
122107-022	● arancione/orange	x1	5	552	483	398	391	2.76	mc. 0.0312

05 vite 4.8 tsp+ m6x30-zincata per il sedile screw 4.8 tsp+ m6x30-zinc for the seat

code	finishing	q.kit
117711-192	○ zincata/zinc	x4

06 supporto schienale scocca legno spacer for plywood shell

code	finishing	q.kit	q.pack	kg.x1	vol.x1
132103-077	● nero/black	x1	20	0.26	mc. 0.055
132105-077	○ avorio/ivory rat1013	x1	20	0.26	mc. 0.055

07 vite tspei m5x40 zincata bianca per lo schienale screw tspei m5x40 white zinc for the back

code	finishing	q.kit
117711-154	○ zincata bianca/white zinc	x3

08 bracciolo destro e sinistro plastica conico left right black plastic conic arm

code	finishing	q.kit	q.pack	a	kg.x1	vol.x1
131703-041	● nero/black	x2	200	205	0.04	mc. 0.0002
131703-042	○ avorio/ivory rat1013	x2	200	205	0.04	mc. 0.0002

09 confezioni viti trucciolari tsp+ d.4x25 zincate (per fissare braccioli) shaving screws tsp+ d.4x25 zinc package (for arms)

code	finishing	q.kit	q.pack
117011-072	○ zincata/zinc	x4	200

key

4-legs/armrest option

main component sizes

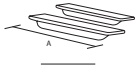

10

10 bracciolo destro e sinistro plastica nero
left right black plastic arm

code	finishing	q.kit	q.pack	a	kg.x1	vol.x1
131703-040	● nero/black	x2	100	200	0,04	mc. 0.0004

4-legs/shell options

main component sizes

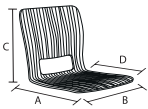

04



spessore 11mm
thickness 11mm

04 magix/young-monoscocca mult. ver. c/inserti
magix/young beech shell w/inserts

code	finishing	q.kit	q.pack	a	b	c	d	kg.x1	vol.x1
122107-015	● faggio/plywood	x1	5	556	487	396	396	3,11	mc. 0.0312
122115-015	● azzurro/blue	x1	5	556	487	396	396	3,11	mc. 0.0312
122116-015	● verde/green	x1	5	556	487	396	396	3,11	mc. 0.0312
122104-015	● tempesta/grey blue	x1	5	556	487	396	396	3,11	mc. 0.0312
122107-021	● arancione/orange	x1	5	556	487	396	396	3,11	mc. 0.0312

and **05** **07**

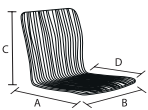

12



spessore 11mm
thickness 11mm

12 magix/fabric-monosc. mult. faggio x imbottiti c/inserti
magix/fabric beech shell for upholstery w/inserts

code	finishing	q.kit	q.pack	a	b	c	d	kg.x1	vol.x1
122107-017	● faggio/plywood	x1	5	556	487	396	396	3,50	mc. 0.0312

13 vite 4.8 tsp+ m6x35 zincata bianca per il sedile
screw 4.8 tsp+ m6x35-white zinc for the seat

code	finishing	q.kit
117711-183	● zincata bianca/white zinc	x4

14 vite tspei m5x45 zincata bianca per lo schienale
screw tspei m5x45 white zinc for the back

code	finishing	q.kit
117711-156	● zincata bianca/white zinc	x3

key

4-legs for castors

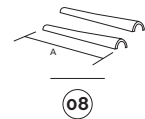
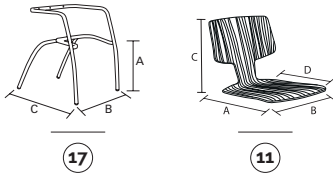
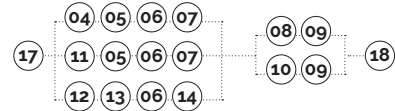

17 magix-telaio quattro gambe per ruote d.25 con riduttori
magix-four legs frame for castors d.25 with adapter

code	finishing	q.kit	q.pack	a	b	c	kg.x1	vol.x1
110103-005	● nero/black	x1	30	450	550	550	3,90	mc. 0,045
110104-005	● grigio/grey	x1	30	450	550	550	3,90	mc. 0,045
110110-005	● cromato/chrome	x1	30	450	550	550	3,90	mc. 0,045

18 doppia ruota d.50 in desmopan con perno montato
twin wheel castor d.50 desmopan with pivot mounted

code	finishing	q.kit
134403-003	● nero/black	x4

11 magix/key-monoscocca mult. ver. c/inserti
magix/key beech shell w/inserts

code	finishing	q.kit	q.pack	a	b	c	d	kg.x1	vol.x1
122107-016	● faggio/plywood	x1	5	552	483	398	391	2,76	mc. 0,0312
122115-016	● azzurro/blue	x1	5	552	483	398	391	2,76	mc. 0,0312
122116-016	● verde/green	x1	5	552	483	398	391	2,76	mc. 0,0312
122104-016	● tempesta/grey blue	x1	5	552	483	398	391	2,76	mc. 0,0312
122107-022	● arancione/orange	x1	5	552	483	398	391	2,76	mc. 0,0312

05 vite 4.8 tsp+ m6x30-zincata per il sedile
screw 4.8 tsp+ m6x30-zinc for the seat

code	finishing	q.kit
117711-192	○ zincata/zinc	x4

06 supporto schienale scocca legno
spacer for plywood shell

code	finishing	q.kit	q.pack	kg.x1	vol.x1
132103-077	● nero/black	x1	20	0,26	mc. 0,055
132105-077	○ avorio/ivory ral1013	x1	20	0,26	mc. 0,055

07 vite tspci m5x40 zincata bianca per lo schienale
screw tspci m5x40 white zinc for the back

code	finishing	q.kit
117711-154	○ zincata bianca/white zinc	x3

08 bracciolo destro e sinistro plastica conico
left right black plastic conic arm

code	finishing	q.kit	q.pack	a	kg.x1	vol.x1
131703-041	● nero/black	x2	200	205	0,04	mc. 0,0002
131703-042	○ avorio/ivory ral1013	x2	200	205	0,04	mc. 0,0002

09 confezioni viti truciolari tsp+ d.4x25 zincate (per fissare braccioli)
shaving screws tsp+ d.4x25 zinc package (for arms)

code	finishing	q.kit	q.pack
117011-072	○ zincata/zinc	x4	200

key

4-legs/armrest option

main component sizes

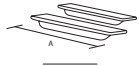

10



10 bracciolo destro e sinistro plastica nero
left right black plastic arm

code	finishing	q.kit	q.pack	a	kg.x1	vol.x1
131703-040	● nero/black	x2	100	200	0,04	mc. 0.0004

4-legs/shell options

main component sizes

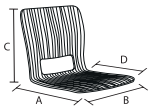

04



spessore 11mm
thickness 11mm

04 magix/young-monoscocca mult. ver. c/inserti
magix/young beech shell w/inserts

code	finishing	q.kit	q.pack	a	b	c	d	kg.x1	vol.x1
122107-015	● faggio/plywood	x1	5	556	487	396	396	3,11	mc. 0.0312
122115-015	● azzurro/blue	x1	5	556	487	396	396	3,11	mc. 0.0312
122116-015	● verde/green	x1	5	556	487	396	396	3,11	mc. 0.0312
122104-015	● tempesta/grey blue	x1	5	556	487	396	396	3,11	mc. 0.0312
122107-021	● arancione/orange	x1	5	556	487	396	396	3,11	mc. 0.0312

and **05** **07**

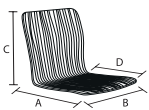

12



spessore 11mm
thickness 11mm

12 magix/fabric-monosc. mult. faggio x imbottiti c/inserti
magix/fabric beech shell for upholstery w/inserts

code	finishing	q.kit	q.pack	a	b	c	d	kg.x1	vol.x1
122107-017	● faggio/plywood	x1	5	556	487	396	396	3,50	mc. 0.0312

13 vite 4.8 tsp+ m6x35 zincata bianca per il sedile
screw 4.8 tsp+ m6x35-white zinc for the seat

code	finishing	q.kit
117711-183	● zincata bianca/white zinc	x4

14 vite tspei m5x45 zincata bianca per lo schienale
screw tspei m5x45 white zinc for the back

code	finishing	q.kit
117711-156	● zincata bianca/white zinc	x3

fabric

swivel

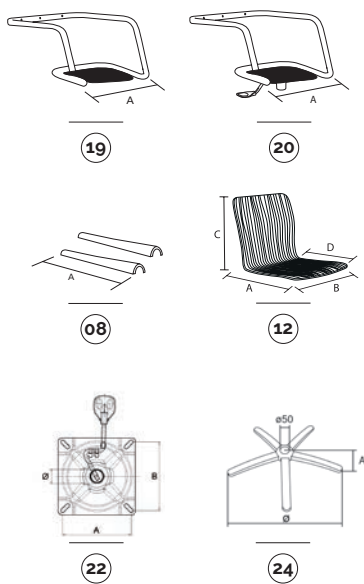
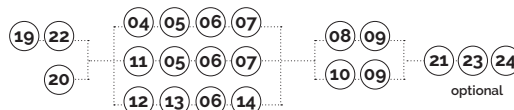

main component sizes

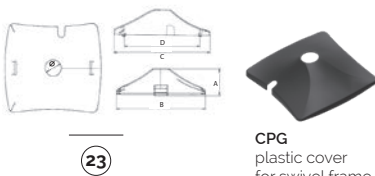

CPG
plastic cover
for swivel frame

19 magix-telaio girevole d.25 con braccioli senza tappi magix-d.25 swivel metal frame arms without caps

code	finishing	q.kit	q.pack	a	kg.x1	vol.x1
110910-034	● cromato/chrome	x1	50	550	5,00	mc. 0.045

20 magix(01)gc-telaio girevole d.25 con braccioli senza tappi con piastra saldata + spatola magix(01)gc-d.25 swivel metal frame arms without caps with gas plate welded + paddle

code	finishing	q.kit
110910-033	● cromato/chrome	x1 50 550

21 tappo copritesta alettato d.25 nero cover head d.25 black

code	finishing	q.kit
134103-250	● nero/black	x2

12 magix/fabric-monosc. mult. faggio x imbottiti c/inserti magix/fabric beech shell for upholstery w/inserts

code	finishing	q.kit	q.pack	a	b	c	d	kg.x1	vol.x1
122107-017	● faggio/plywood	x1	5	556	487	396	396	3,50	mc. 0.0312

13 vite 4.8 tsp+ m6x35 zincata bianca per il sedile screw 4.8 tsp+ m6x35-white zinc for the seat

code	finishing	q.kit
117711-183	○ zincata bianca/white zinc	x4

14 vite tspei m5x45 zincata bianca per lo schienale screw tspei m5x45 white zinc for the back

code	finishing	q.kit
117711-156	○ zincata bianca/white zinc	x3

06 supporto schienale scocca legno spacer for plywood shell

code	finishing	q.kit	q.pack	kg.x1	vol.x1
132103-077	● nero/black	x1	20	0,26	mc. 0.055
132105-077	○ avorio/ivory ral1013	x1	20	0,26	mc. 0.055

08 bracciolo destro e sinistro plastica conico left right black plastic conic arm

code	finishing	q.kit	q.pack	a	kg.x1	vol.x1
131703-041	● nero/black	x2	200	205	0,04	mc. 0.0002
131703-042	○ avorio/ivory ral1013	x2	200	205	0,04	mc. 0.0002

09 confezioni viti trucciolari tsp+ d.4x25 zincate (per fissare braccioli) shaving screws tsp+ d.4x25 zinc package (for arms)

code	finishing	q.kit	q.pack
117011-072	○ zincata/zinc	x4	200

22 pss28nr-piastra sgabello c/spat. c/28 3' l4 nera pss28nr- square metal plate with straight lever c/28 3' l4

code	finishing	q.kit	q.pack	a	b	o	kg.x1	vol.x1
113003-104	● nero/black	x1	25	150	150	28	1,23	mc. 0.002

23 cpg-copertina in plastica per telaio girevole cpg-plastic cover for swivel frame

code	finishing	q.kit	q.pack	a	b	c	d	o	kg.x1	vol.x1
130903-000	● nero/black	x1	50	60	200	210	167	36	0,1	mc. 0.0015

24 b40 base in metallo d.640 con coprisaldatura b40 metal base d.640 with cover welding

code	finishing	q.kit	q.pack	a	o	kg.x1	vol.x1
110210-027	● cromato/chrome	x1	5	60	640	2,85	mc. 0.014

young / key / fabric

bench

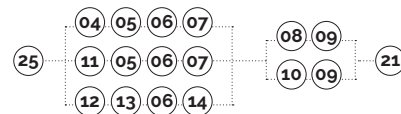

25 magix-telaio panca d.25 con braccioli senza tappi
magix-d.25 bench metal frame arms without caps

code	finishing	q.kit	q.pack	a	kg.x1	vol.x1
110710-200	● cromato/chrome	x1	60	550	5,00	mc. 0,045

26 got(03) trave per panca 80x40
got(03) beam for bench 80x40

code	finishing		q.kit	q.pack	a	b	c	kg.x1	vol.x1
110703-190	● nero/black	2 posti/2 seats	x1	1	1160	80	40	3,20	mc. 0,0045
110704-190	● grigio/grey	2 posti/2 seats	x1	1	1160	80	40	3,20	mc. 0,0045
110703-191	● nero/black	3 posti/3 seats	x1	1	1710	80	40	4,71	mc. 0,005
110704-191	● grigio/grey	3 posti/3 seats	x1	1	1710	80	40	4,71	mc. 0,005
110703-192	● nero/black	4 posti/4 seats	x1	1	2260	80	40	6,22	mc. 0,0085
110704-192	● grigio/grey	4 posti/4 seats	x1	1	2260	80	40	6,22	mc. 0,0085
110703-193	● nero/black	5 posti/5 seats	x1	1	2800	80	40	7,72	mc. 0,01
110704-197	● grigio/grey	5 posti/5 seats	x1	1	2800	80	40	7,72	mc. 0,01

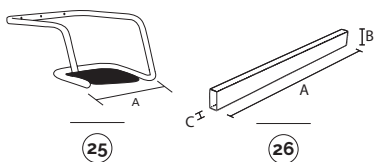

for the components below, see page 86

04 05 06 07 08 09

for the components below, see page 90

11

for the components below, see page 92

12 13 14 21

for the bench components, see page 249

bench/armrest option



10 bracciolo destro e sinistro plastica nero
left right black plastic arm

code	finishing	q.kit	q.pack	a	kg.x1	vol.x1
131703-040	● nero/black	x2	100	200	0,04	mc. 0,0004

OPTIONAL
bench
connector

E-USB NEW
bench plug

JIM NEW
bench leg

APOLL
bench arm

90GM
bench leg

90GF
bench leg

100GM
bench leg

200GM
bench leg

PIONEER
bench arm

CUT
bench leg

SLIM
bench leg

CUT
bench arm

SLIM
bench arm



plastic

metal

aluminium

main component sizes

optionals